

EPCOS Product Profile 2012

Sensors for Home Appliances

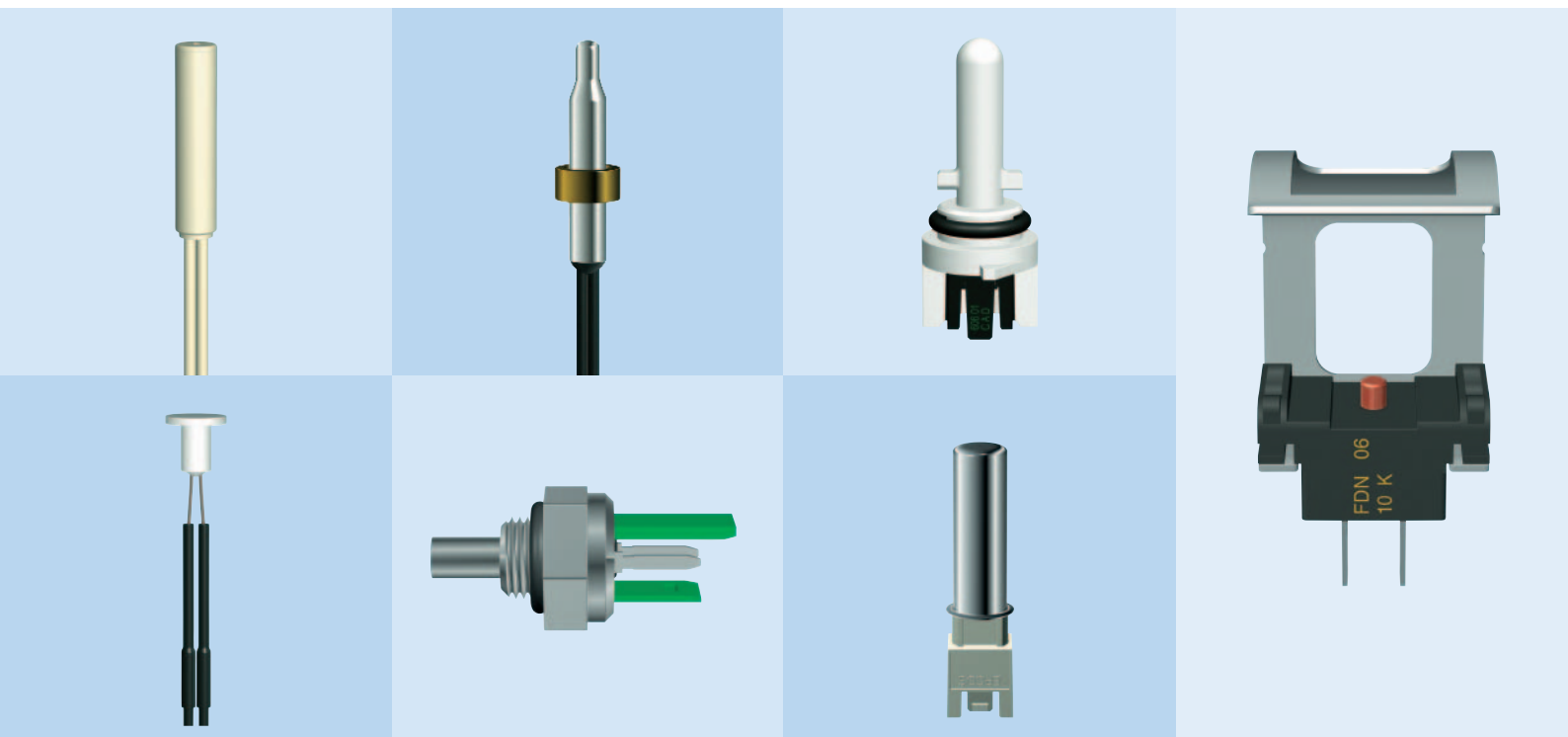

Sensors for Home Appliances

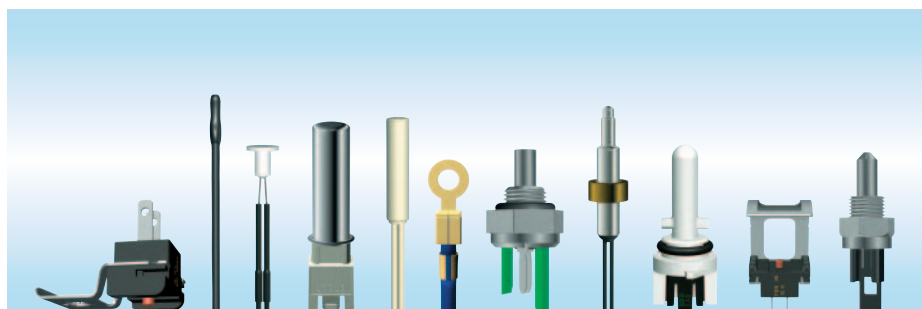

Contents

Important notes	4
Preview	5
Overview of sensors	6
Sensors for household appliances	7
Washing and drying	
■ K514 / K524	7
■ K276 / Z276 / Z277 / Z278	8
■ Z509 / Z901	9
Dishwashing	
■ Z606	10
Cooling and freezing	
■ M2020 / M2030 / M2035 / M3020 / M3035	11
■ M2025 / M2010 / M1005	12
Small appliances	
■ K504 / K560 / K1560	13
■ M703 / M1703	14
■ K45 / K302 / Triangle sensor	15
Sensors for heating, ventilation and air-conditioning (HVAC) appliances	16
Heating	
■ T120 (Clip-on sensor) / F120 (Surface-mounted sensor)	16
■ Z81 / K301	17
■ M834	18
■ Pressure sensors	19
Air-conditioning	
■ K500 / K501 / K502 / K505 / K510 / M500 / M510 / M800	20
Design and development process	21
Thermal response time measurement of NTC sensors	22
Cautions and warnings	24
Symbols and terms	25
Get in contact	26

Important Notes

The following applies to all products named in this publication:

1. Some parts of this publication contain **statements about the suitability of our products for certain areas of application**. These statements are based on our knowledge of typical requirements that are often placed on our products in the areas of application concerned. We nevertheless expressly point out **that such statements cannot be regarded as binding statements about the suitability of our products for a particular customer application**. As a rule, EPCOS is either unfamiliar with individual customer applications or less familiar with them than the customers themselves. For these reasons, it is always ultimately incumbent on the customer to check and decide whether an EPCOS product with the properties described in the product specification is suitable for use in a particular customer application.
2. We also point out that **in individual cases, a malfunction of electronic components or failure before the end of their usual service life cannot be completely ruled out in the current state of the art, even if they are operated as specified**. In customer applications requiring a very high level of operational safety and especially in customer applications in which the malfunction or failure of an electronic component could endanger human life or health (e.g. in accident prevention or life-saving systems), it must therefore be ensured by means of suitable design of the customer application or other action taken by the customer (e.g. installation of protective circuitry or redundancy) that no injury or damage is sustained by third parties in the event of malfunction or failure of an electronic component.
3. **The warnings, cautions and product-specific notes must be observed.**
4. In order to satisfy certain technical requirements, **some of the products described in this publication may contain substances subject to restrictions in certain jurisdictions (e.g. because they are classed as hazardous)**. Useful information on this will be found in our Material Data Sheets on the Internet (www.epcos.com/material). Should you have any more detailed questions, please contact our sales offices.
5. We constantly strive to improve our products. Consequently, **the products described in this publication may change from time to time**. The same is true of the corresponding product specifications. Please check therefore to what extent product descriptions and specifications contained in this publication are still applicable before or when you place an order.

We also reserve the right to discontinue production and delivery of products. Consequently, we cannot guarantee that all products named in this publication will always be available.

The aforementioned does not apply in the case of individual agreements deviating from the foregoing for customer-specific products.
6. Unless otherwise agreed in individual contracts, **all orders are subject to the current version of the “General Terms of Delivery for Products and Services in the Electrical Industry” published by the German Electrical and Electronics Industry Association (ZVEI)**.
7. The trade names EPCOS, BAOKE, Alu-X, CeraDiode, CSMP, CSSP, CTVS, DeltaCap, DigiSiMic, DSSP, FormFit, MiniBlue, MiniCell, MKD, MKK, MLSC, MotorCap, PCC, PhaseCap, PhaseCube, PhaseMod, PhiCap, SIFERRIT, SIFI, SIKOREL, SilverCap, SIMDAD, SiMic, SIMID, SineFormer, SIOV, SIP5D, SIP5K, ThermoFuse, WindCap are **trademarks registered or pending** in Europe and in other countries. Further information will be found on the Internet at www.epcos.com/trademarks.

Preview



Temperature sensing and control are among the most important and well-established functions in home appliances, which represent one of the largest markets for electronic products. Home appliances include both large household appliances such as washing machines, driers, dishwashers, refrigerators, freezers, stoves and ovens, and small household appliances such as coffee makers, induction hobs, irons or ice makers. Moreover, heating, ventilation and air-conditioning (HVAC) appliances account for a further substantial segment of this market.

In recent years we have introduced a great variety of new sensors and sensor systems to the home appliance market and continuously develops innovative products to meet customers' requirements.

EPCOS sensors stand out for excellent measuring accuracy and long-term stability. Advanced technologies allow cost-efficient and large-scale production of reliable sensors. Thus, we are able to offer sensors over-molded with plastic or encapsulated in specific materials for reliable use in adverse environments for a large range of temperatures. They can be delivered in numerous shapes and with a wide variety of cable and connector geometries.

If standard types do not match the purpose – we can also supply application-specific sensors with customized parameters.

Our design centers and plants for sensor products – in Berlin/ Germany, Deutschlandsberg/ Austria, Zhuhai/ China and Batam/ Indonesia – are certified to ISO 9001:2000, ISO/TS 16949:2002 and ISO 14001:2004.

With our comprehensive sensor portfolio we help appliances manufacturers make their products safer, more convenient to use and more energy-efficient.

This product profile can only present a selection of our continuously growing portfolio of sensor products, which not only measure temperature, but are also able to sense pressure. We are also able to offer an extensive range of pressure sensors that are suitable for home appliances. For example, pressure sensors can be used in modern heating appliances such as heat pumps to improve their operating efficiency.

Overview of Sensors

Overview of types							
Type	Household appliances				HVAC		Page
	Washing and drying	Dishwashing	Cooling and freezing	Small appliances	Heating	Air-conditioning	
K514	●			●	●		7
K524	●			●	●		7
K276	●	●					8
Z276	●	●					8
Z277	●						8
Z278	●	●					8
Z509	●						9
Z901	●						9
Z606		●					10
M2020			●				11
M2030			●				11
M2035			●				11
M3020			●				11
M3035			●				11
M1005			●				12
M2010			●				12
M2025			●				12
K504	●	●		●	●		13
K560	●			●			13
K1560	●			●			13
M703				●			14
M1703				●			14
K45				●			15
K302				●			15
Triangle sensor				●	●		15
T120					●		16
F120					●		16
Z81					●		17
K301					●		17
M834					●		18
Pressure sensors	●				●		19
K500					●	●	20
K501					●	●	20
K502					●	●	20
K505					●	●	20
K510					●	●	20
M500			●			●	20
M510			●			●	20
M800						●	20

Sensors for Household Appliances: Washing and Drying

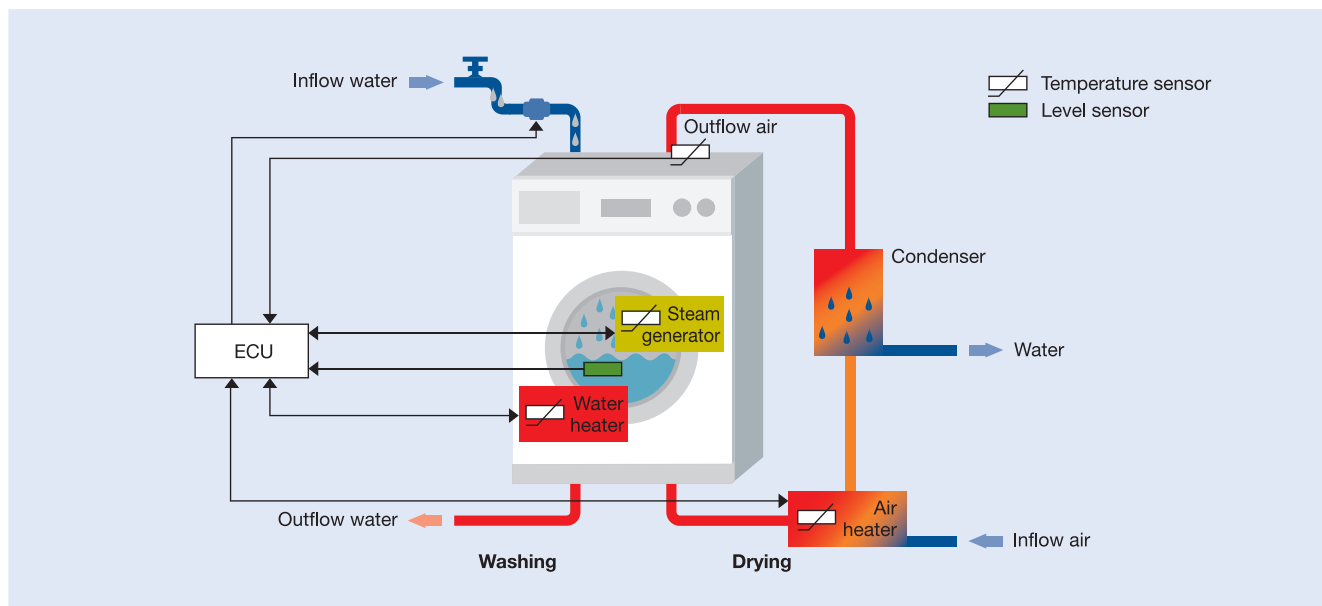



Washing and Drying





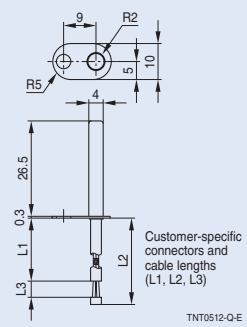

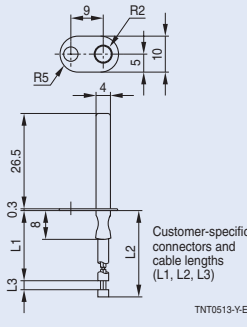
The temperature sensor in washing machines allows precise control of water temperature (K276, Z276, Z277, Z278). A pressure sensor can be used to measure the level of water in the drum.

In clothes dryers temperature sensors determine the temperature of hot air flowing into the drum (Z509, K514, K524) and that of the vented air (K276, Z276, Z901, Z277). To optimize anti-wrinkling treatment of laundry a temperature sensor can be integrated in the steam generator (K504, K514, K1560, K560).

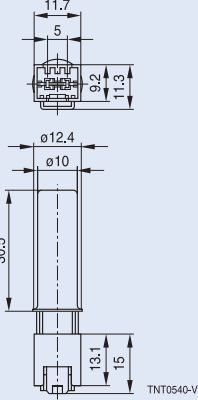

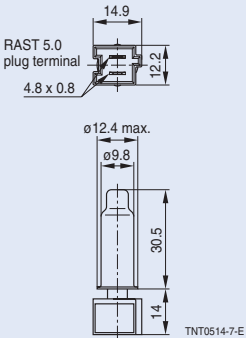
K514 / K524

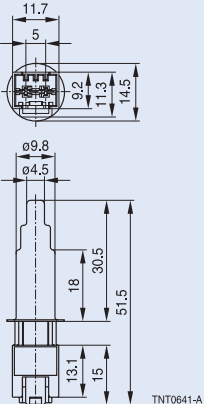
Type	Features	$\tau_{a, air}$ s	V_{ins} @ 1 s VAC	Dimensions mm
 K514	<ul style="list-style-type: none"> ● NTC thermistor potted into a stainless steel case with cable outlet ● Temperature range: -10 to +200 °C ● Wire heat-resistant up to 200 °C (PTFE insulated wire in fiberglass sleeve) ● Fast and simple flange installation ● Customizable sensor design (cable lengths, R/T characteristics, connectors, case) 	approx. 25	>1250	 Customer-specific connectors and cable lengths (L1, L2, L3) TNT0512-Q-E
 K524	<ul style="list-style-type: none"> ● NTC thermistor immersed in a stainless steel case with cable outlet ● Temperature range: -10 to +300 °C ● Wire heat-resistant up to 200 °C (PTFE insulated wire in fiberglass sleeve) ● Fast and simple flange installation ● Customizable sensor design (cable lengths, R/T characteristics, connectors, case) 	approx. 30	>1250	 Customer-specific connectors and cable lengths (L1, L2, L3) TNT0513-Y-E

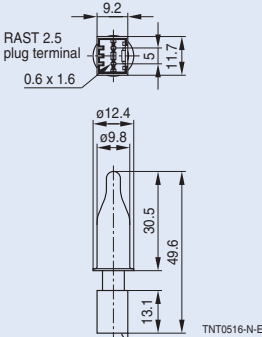
Sensors for Household Appliances: Washing and Drying

K276 / Z276 / Z277 / Z278				
Type	Features	$\tau_{a, \text{water}}$ s	$V_{\text{ins}} @ 1 \text{ s}$ VAC	Dimensions mm
K276 	<ul style="list-style-type: none"> ● NTC thermistor potted into a stainless steel case with RAST connector (RAST 2.5, optional with bar for snap-fit or RAST 5) ● Suitable for corrosive environments (suds, water) ● K276 is market standard for water temperature measurement in washing machines ● Temperature range -10 to +100 °C ● Certified to EN 60539-1 ● Designed to DIN EN 60730-1/ VDE, protection class 2 (K276, Z276, Z277) ● UL approved (file E69802) ● Long-term stability ● Customizable sensor design (R/T characteristics, connectors) 	20	3750	 TNT0540-V
Z276 		10	3750	 TNT0514-7-E
Z277 		7	3750	 TNT0641-A
Z278 		4	500	 TNT0516-N-E

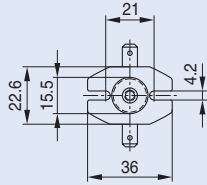
Sensors for Household Appliances: Washing and Drying

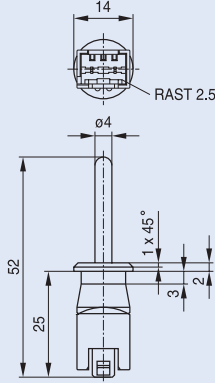
Z509 / Z901				
Type	Features	$\tau_{a, air}$ s	V_{ins} @ 1 s VAC	Dimensions mm
Z509 	<ul style="list-style-type: none"> ● NTC thermistor molded in plastic case with contacts ● Temperature range 0 to +145 °C (plastic material PA6.6-GF30), peak temperatures up to 175 °C/ 1000 h ● Popular plastic flange system for simple installation ● Customizable sensor design (R/T characteristics, connectors) 	approx. 65	>1500	 TNT0438-D
Z901 	<ul style="list-style-type: none"> ● NTC thermistor potted into stainless case with molded RAST 2.5 connector ● Temperature range -10 to +100 °C ● Customizable sensor design (R/T characteristics, connectors) 	approx. 30	>1250	 TNT0607-V

Also suitable: K504 and K560 / K1560, page 13.

Sensors for Household Appliances: Dishwashing

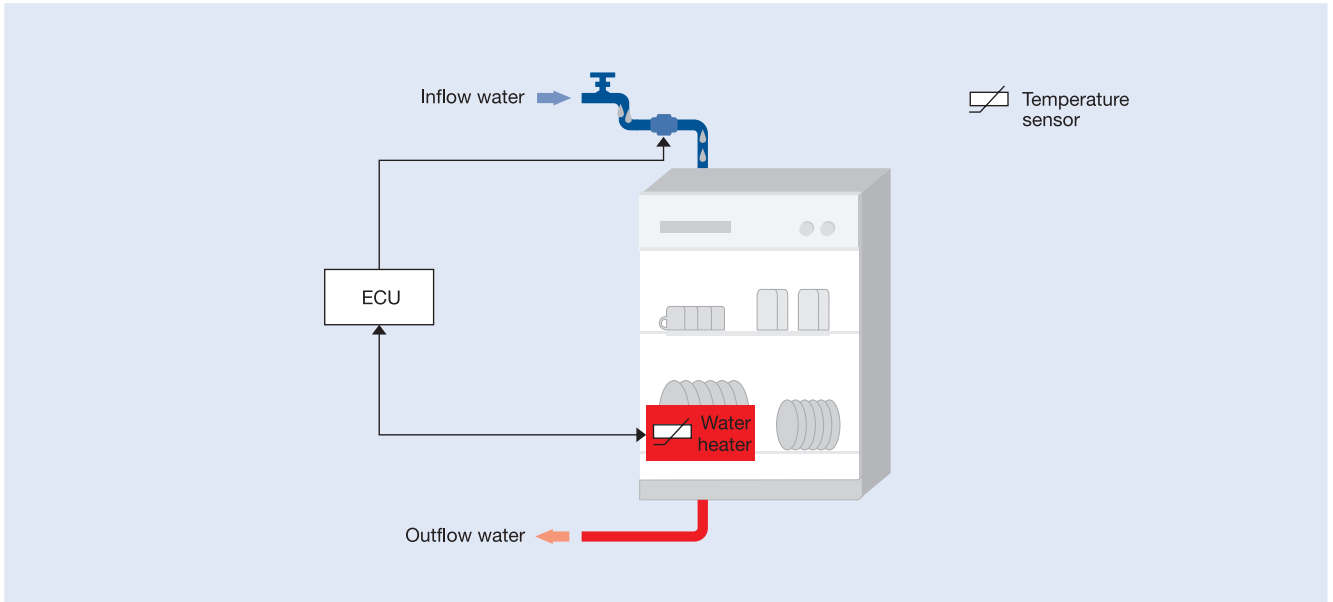

Dishwashing

Temperature sensors are used to measure the water temperature (K276, Z276, Z278, Z606, K504). The ECU uses the information from the sensor for closed-loop regulation of the pre-defined water temperature for each step in the dishwasher program.

Z606

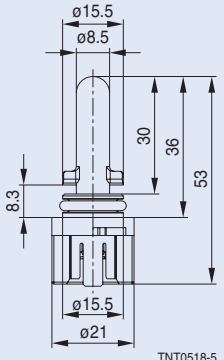
Type	Features	Temperature range	V _{ins} @ 1 s VAC	Dimensions mm
Z606 	<ul style="list-style-type: none"> ● NTC thermistor potted into molded plastic case with RAST 2.5 connector ● Plastic case resistant to ingress of moisture/ water ● Designed to DIN EN 60730-1/ VDE, protection class 2 ● Bayonet fixing and RAST 2.5 connector for fast and simple installation ● Customizable sensor design (R/T characteristics, connectors) 	0 ... +85 °C	>3750	 <p>TNT0518-5</p>

Also suitable: K276, Z276 and Z278, page 8; K504, page 13.

Sensors for Household Appliances: Cooling and Freezing

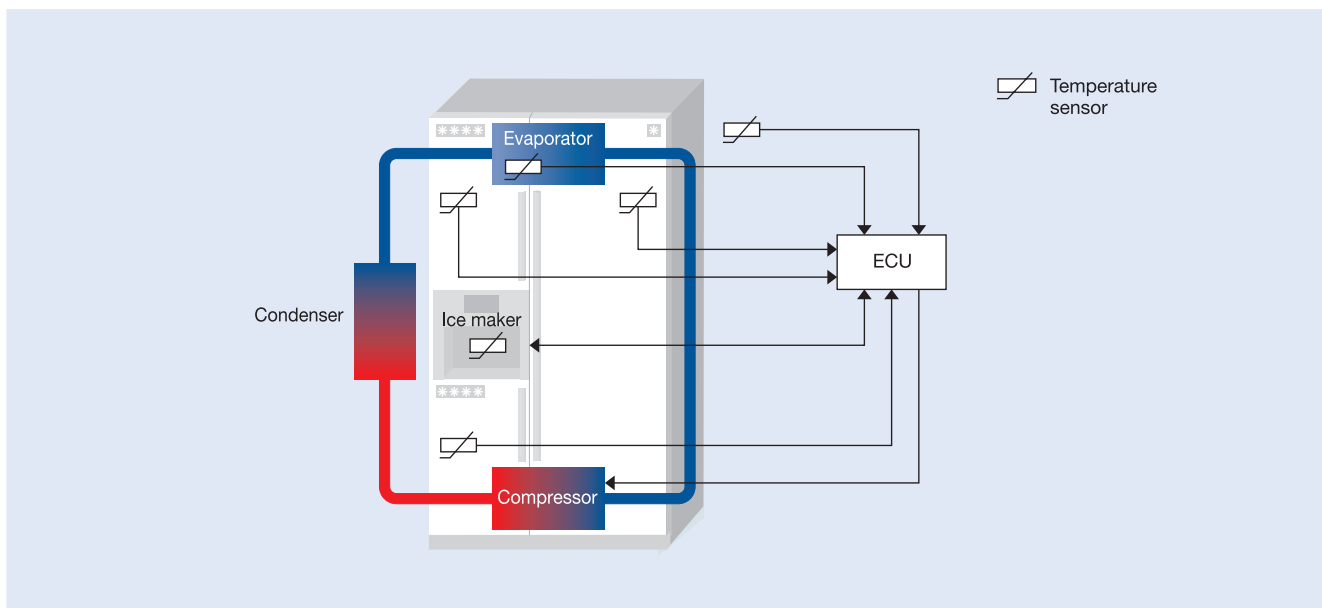

Cooling and Freezing



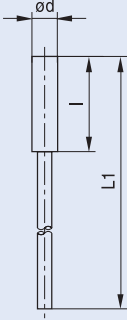

Temperature sensors in refrigerators and freezers measure temperature of cooling compartment, guard against icing in the evaporator, and support ice cube preparation (M2000 and M3000 series, M1005), as well as detecting ambient temperature (M500).

M2020 / M2030 / M2035 / M3020 / M3035

Type	Features	Temperature range	Dimensions mm
M2020 	<ul style="list-style-type: none"> ● NTC thermistor in molded plastic case with cable outlet ● Proven design for many years in refrigerator and freezer applications ● Highly resistant to water/ moisture: $\Delta R_{25}/R_{25} < 2\%$ for rapid temperature cycle test in water -20 to +30 °C/ 50.000 cycles $\Delta R_{25}/R_{25} < 2\%$ for storage test in water +30 °C/ 4.000 h $\Delta R_{25}/R_{25} < 2\%$ for storage test in damp heat, steady state 40 °C/ 93% r.h./ 56 days ● Designed to DIN EN 60730-1/ VDE, protection class 2 ● UL approved (file E69802) ● Cable text and/ or color marking for installation and identification purposes ● Customizable sensor design (cable lengths, R/T characteristics, connectors, marking) <p>Additionally for M2020 / M2030 / M2035</p> <ul style="list-style-type: none"> ● PVC double insulated connecting cable <p>Additionally for M3020 / M3035</p> <ul style="list-style-type: none"> ● PVC-free double insulated connecting cable ● Improved performance at temperatures up to 80 °C: $\Delta R_{25}/R_{25} < 2\%$ for storage test in damp heat, steady state 85 °C/ 85% r.h./ 56 days $\Delta R_{25}/R_{25} < 2\%$ for storage test in water +80 °C/ 2000 h 	-40 ... +80 °C	 <p>Customer-specific cable length (L1)</p> <p>TNT0523-6-E</p>

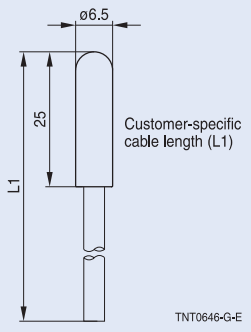
Also suitable: M500 and M510, page 20.

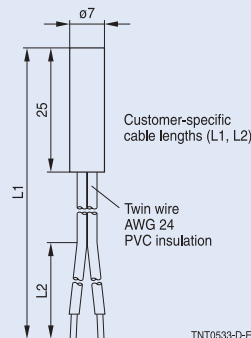
Sensors for Household Appliances: Cooling and Freezing

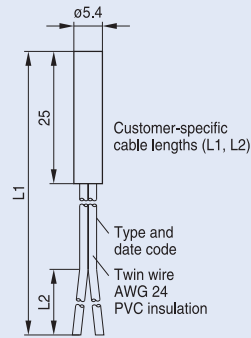
M2025 / M2010 / M1005					
Type	Features	Temperature range	Dimensions mm		
 <p>M2025</p>	<ul style="list-style-type: none"> ● NTC thermistor in molded plastic case with cable outlet ● Highly resistant to water/ moisture ● Cable text and/ or color marking for installation and identification purposes ● PVC double insulated connecting cable (M2025), PVC single insulated twin cable (M2010, M1005) ● Customizable sensor design (cable lengths, R/T characteristics, connectors) 	-40 ... +80 °C	 <p>Customer-specific cable length (L1)</p> <p>TNT0646-G-E</p>		
 <p>M2010</p>			-30 ... +80 °C	 <p>Customer-specific cable lengths (L1, L2)</p> <p>Twin wire AWG 24 PVC insulation</p> <p>TNT0533-D-E</p>	
 <p>M1005</p>				-30 ... +80 °C	 <p>Customer-specific cable lengths (L1, L2)</p> <p>Type and date code</p> <p>Twin wire AWG 24 PVC insulation</p> <p>TNT0532-E-E</p>

General technical data and dimensions				
Type	$\tau_{a, \text{water}}$ s	$V_{\text{ins}} @ 1 \text{ s}$ VAC	Sensor head dimensions	
			$\varnothing d$ mm	l mm
M2020	approx. 35	3750	8	30
M2030	approx. 45	3750	9	49
M2035	approx. 40	3750	9	30
M3020	approx. 35	3750	8	30
M3035	approx. 40	3750	9	30
M2025	approx. 25	1250	6.5	25
M2010	approx. 25	1250	7	25
M1005	approx. 15	1250	5.4	25



Sensors for Household Appliances: Small Appliances

Small Appliances

Temperature sensors are used to make products such as irons, coffee makers, tea makers, kettles, toasters, rice cookers, bottle warmers, ice makers, electric grills, portable cookers (K504, K514, K524, M703, K560, K1560, M1703, K302, K45) more energy efficient, safer and more convenient to use.

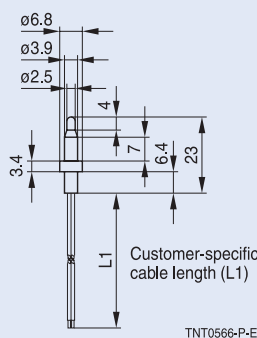

New applications include induction hobs, microwave ovens and food processors. For these applications EPCOS offers sensors with a high temperature range up to 280 °C and with different fixation designs to meet a wide variety of demands. Most types are available with different cable lengths, connectors, resistance ratings, rated temperatures, resistances tolerances and R/T-curves.

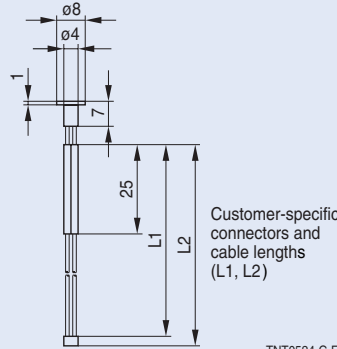
K504 / K560 / K1560

Type	Features	Temperature range	V_{ins} @ 1 s VAC	Dimensions mm
 <p>K504</p>	<ul style="list-style-type: none"> ● NTC thermistor potted into a medium-resistant stainless steel case ● Short thermal response time $\tau_{a, water}$ 1 to 4 s ● Wire heatproof up to 200 °C ● Customizable sensor design (cable lengths, R/T characteristics, connectors) 	-20 ... +150 °C	>1250	 <p>Customer-specific cable length (L1)</p> <p>TNT0566-P-E</p>
 <p>K560 K1560</p>	<ul style="list-style-type: none"> ● NTC thermistor potted into a aluminium (K560) or ceramic (K1560) case with cable outlet ● Short-term peak temperature up to +280 °C ● Fast thermal response in air stream $\tau_{a, air}$: K560 approx. 15 s/ K1560 approx. 20 s ● Virtually unaffected by electromagnetic energy ● Flange housing for good thermal coupling to hot surface ● Customizable sensor design (cable lengths, R/T characteristics, connectors) 	-10 ... +250 °C	K560: >1250 K1560: >3000	 <p>Customer-specific connectors and cable lengths (L1, L2)</p> <p>TNT0524-C-E</p>



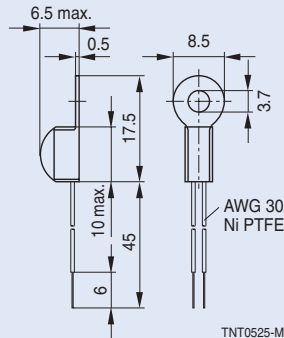

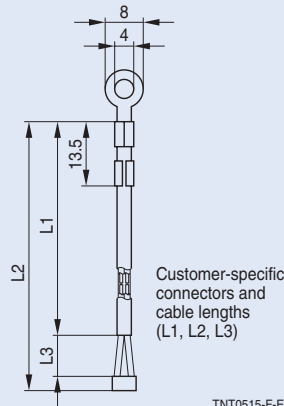
Also suitable: K514 and K524, page 7.

Sensors for Household Appliances: Small Appliances

M703 / M1703				
Type	Features	Temperature range	V_{ins} @ 1 s VAC	Dimensions mm
<p>M703</p> 	<ul style="list-style-type: none"> ● NTC thermistor encapsulated in metal tag case ● Good thermal coupling through metal tag ● UL approved (file E69802) ● Wire heatproof up to +200 °C ● Fast and simple screw-on installation ● Customizable sensor design (cable lengths, R/T characteristics, connectors) 	-20 ... +125 °C	>1000	
<p>M1703</p> 	<ul style="list-style-type: none"> ● NTC thermistor encapsulated in brass metal tag case ● Good thermal coupling through brass metal tag ● Wire heatproof up to +200 °C (PTFE insulated wire in fiberglass sleeve) ● Fast and simple screw-on installation ● Customizable sensor design (cable lengths, R/T characteristics, connectors) 	-10 ... +280 °C	>1250	

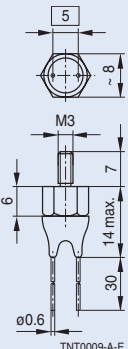
Also suitable: K514 and K524, page 7.

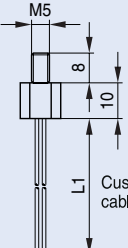
Sensors for Household Appliances: Small Appliances

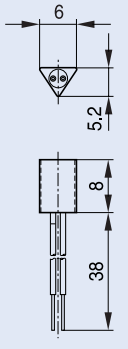
K45 / K302 / Triangle sensor				
Type	Features	Temperature range	V _{ins} @ 1 s VAC	Dimensions mm
K45 	<ul style="list-style-type: none"> ● NTC thermistor potted into a screw-in aluminum case ● Thermal response time in air stream approx. 75 s ● Good thermal coupling through screw-in case (M3 thread) ● Tinned copper leads ● Fast and simple screw-in installation (e.g. on chassis) 	-20 ... +125 °C	>2500	 <p>TNT0009-A-E</p>
K302 	<ul style="list-style-type: none"> ● NTC thermistor potted into a screw-in brass case with cable outlet ● Wire heatproof up to 200 °C ● Fast and simple screw-in installation ● Customizable sensor design (cable lengths, R/T characteristics, connectors) 	-20 ... +150 °C	>1250	 <p>Customer-specific cable length (L1)</p> <p>TNT0588-K</p>
Triangle sensor 	<ul style="list-style-type: none"> ● NTC thermistor potted into a triangular brass case with cable outlet ● Good thermal coupling ● PTFE insulated wire, AWG 30 ● Customizable sensor design (cable lengths, R/T characteristics) 			 <p>TNT0592-D</p>

Sensors for Heating, Ventilation and Air-Conditioning (HVAC) Appliances

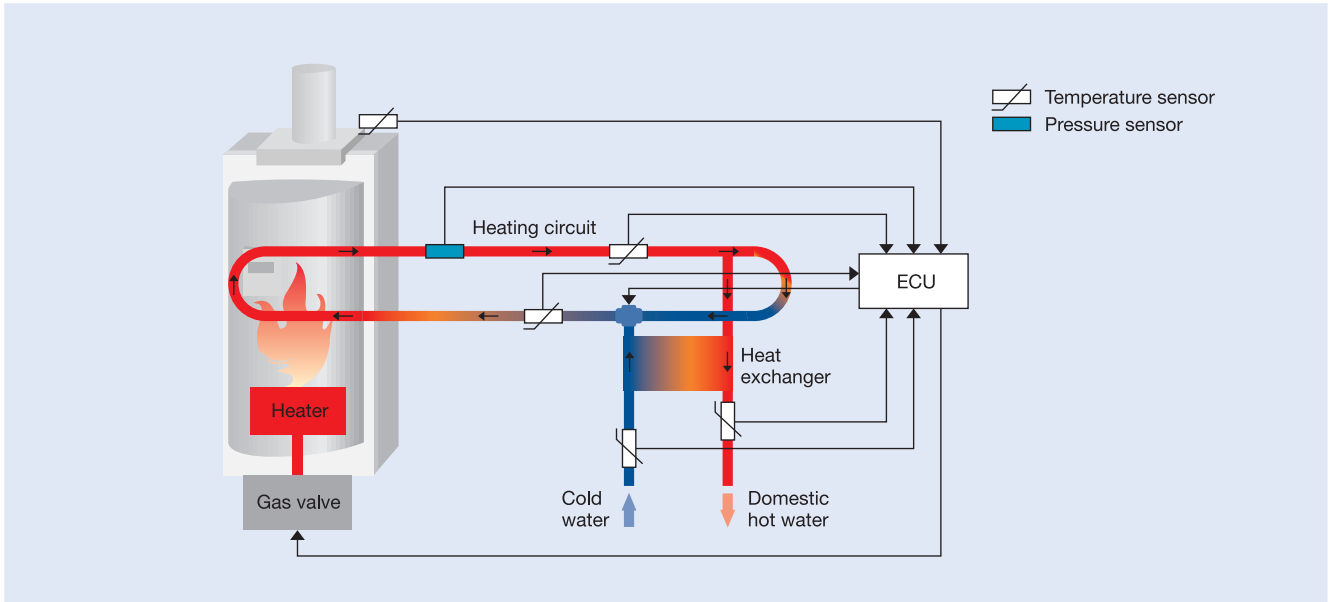

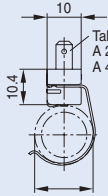
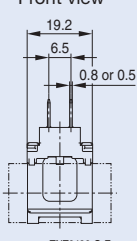
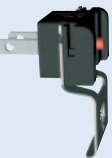
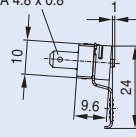
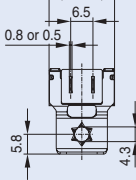

Heating

Temperature sensors are integrated at various points in a heating system – in the forward and return flow of heating water or in the boiler, in the inflow and outflow of domestic hot water, in the exhaust to measure flue gas, in hot water tanks, in control units and thermostats to meter room temperature. In addition, pressure sensors can also serve to measure refrigerant pressure in heat pumps.

T120 / F120				
Type	Features	Temperature range	V _{ins} @ 1 s VAC	Dimensions mm
Clip-on sensor T120 	<ul style="list-style-type: none"> ● NTC thermistor potted into a copper case, moulded with contacts ● Pipe mounted sensor to measure fluid temperature ● Short response time on pipe through glass-encapsulated NTC ($\tau_{a,surface} < 3$ s) ● Fast and simple installation ● For pipes with diameter 13.5, 15, 18, 19 and 22 mm ● 2.8 × 0.5 or 4.8 × 0.8 mm plug terminals ● Customizable sensor design (R/T characteristics, clip) 	+5 ... +110 °C	500	Side view  Front view  For pipe diameter (PD): ø 13.5, 15, 18, 19 and 22 mm TNT0490-Q-E
Surface-mounted sensor F120 	<ul style="list-style-type: none"> ● NTC thermistor potted into a copper case, moulded with contacts ● Sensor to measure surface temperature (boilers, etc.) ● Short response time on surface through glass-encapsulated NTC ($\tau_{a,surface} < 3$ s) ● Fast and simple screw installation ● 2.8 × 0.5 or 4.8 × 0.8 mm plug terminals ● Customizable sensor design (R/T characteristics, bracket) 	+5 ... +110 °C	500	Tab connector A 2.8 × 0.5 or A 4.8 × 0.8   TNT0526-V-E

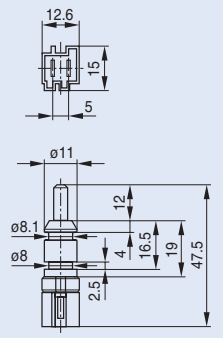
Sensors for Heating, Ventilation and Air-Conditioning (HVAC) Appliances

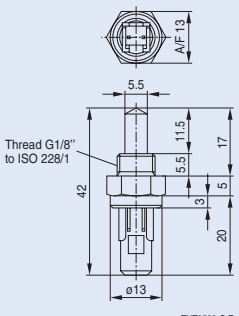
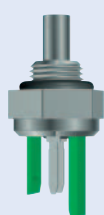
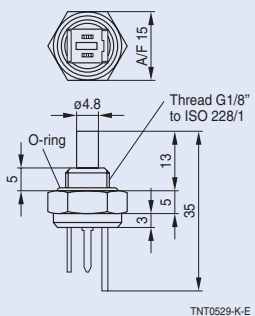
Z81 / K301				
Type	Features	Temperature range	V _{ins} @ 1 s VAC	Dimensions mm
Z81 	<ul style="list-style-type: none"> ● NTC thermistor potted into a dezincification-resistant brass case ● Temperature measurement in heating water and domestic hot water ● Short response time in water ($\tau_{a,water} < 5$ s) ● Sealing with O-ring ● RAST 5 connector ● Customizable sensor design (R/T characteristics, connectors) 	5 ... +110 °C	500	 <p>TNT0527-4</p>
K301 	<ul style="list-style-type: none"> ● NTC thermistor potted into a brass case ● Temperature measurement in heating water ● Short response time in water ($\tau_{a,water}$ approx. 5 s) ● Sealing with O-ring ● Simple screw installation (G1/8" thread) ● Tab connector and mini-module connector variants 	-30 ... +110 °C	2500	 <p>Thread G1/8" to ISO 228/1</p> <p>TNT0528-C-E</p>
K301 				 <p>O-ring</p> <p>Thread G1/8" to ISO 228/1</p> <p>TNT0529-K-E</p>

Sensors for Heating, Ventilation and Air-Conditioning (HVAC) Appliances

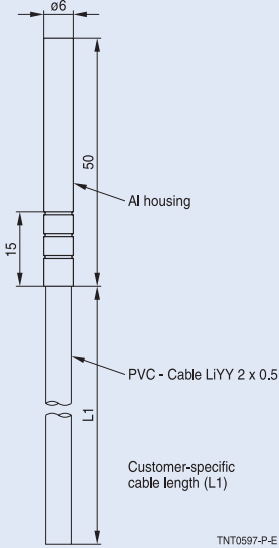
M834				
Type	Features	Temperature range	V_{ins} @ 1 s VAC	Dimensions mm
M834 	<ul style="list-style-type: none"> ● NTC thermistor immersed into an aluminum case with cable outlet ● Thermal response time in air $\tau_{a, air}$: approx. 50 s ● Customizable sensor design (cable lengths, R/T characteristics, connectors) 	-10 ... +100 °C	500	 <p>Technical drawing of the M834 sensor showing dimensions: diameter $\phi 6$, housing length 50, cable length L1, and a 15mm section at the top. Labels include "Al housing", "PVC - Cable LiYY 2 x 0,5", and "Customer-specific cable length (L1)".</p> <p>TNT0597-P-E</p>

Also suitable: K514 and K524, page 7.

Sensors for Heating, Ventilation and Air-Conditioning (HVAC) Appliances

Pressure sensors

Type

Features

AC Pressure transmitters

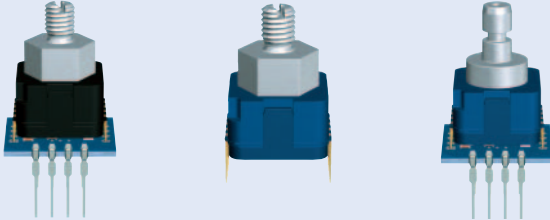

- Piezoresistive silicon pressure transmitter in plastic housing
- Absolute or relative pressure detection
- Pressure range 0.1 to 25 bar
- Output signal 0.5 to 4.5 V, calibrated and temperature-compensated
- Operating temperature range: -30 to +85 °C
- Compensated temperature range: 0 to +70 °C
- Designed for PCB mounting, can be integrated into complex devices
- Pressure connection flange M5 or tube fitting
- Custom versions with casing

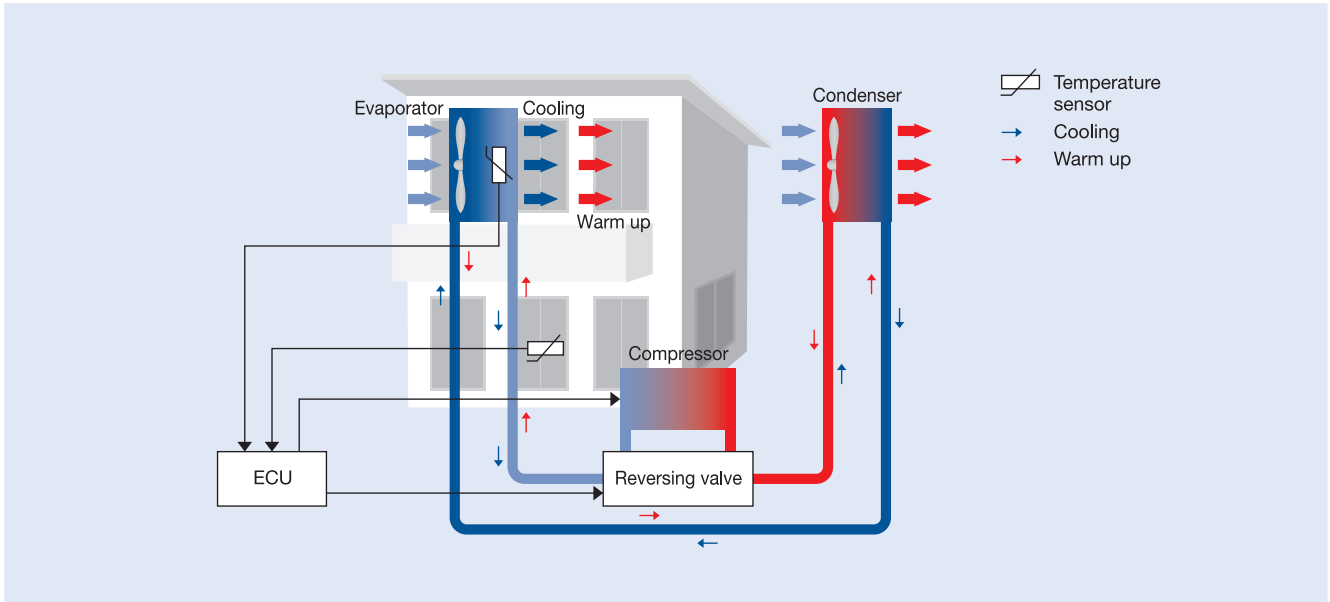

Sensors for Heating, Ventilation and Air-Conditioning (HVAC) Appliances



Air-conditioning

Sensors measure temperature on the evaporator to prevent icing, on the air outlet or in the room.

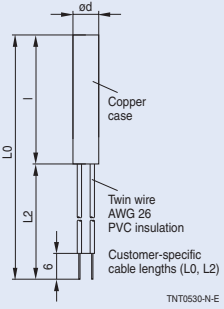
K500 / K501 / K502 / K505 / K510 / M500 / M510 / M800

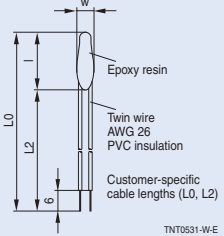
Type	Features	Temperature range	V _{ins} @ 1 s VAC	Dimensions mm
 K500	<ul style="list-style-type: none"> ● Copper housing with good thermal conductivity ● Temperature measurement on the evaporator ● Response time in water approx. 8 s ● Twin cable variants AWG 22, AWG 24 and AWG 26 or double insulated cable ● Customizable sensor design (cable lengths, R/T characteristics, connectors) 	-30 ... +100 °C	1500	 <p>TNT0530-N-E</p>
 M500 M800	<ul style="list-style-type: none"> ● NTC thermistor with epoxy encapsulation ● Measurement of air temperature ● M800 version with improved humidity resistance ● Twin cable variants AWG 22, AWG 24 and AWG 26 ● Customizable sensor design (cable lengths, R/T characteristics, connectors) 	-30 ... +100 °C	1250	 <p>TNT0531-W-E</p>

Head dimensions

Type	Head diameter (ød) mm	Head length (l) mm	Type	Head diameter (w) mm	Head length (l) mm
K500	6	30	M500	4 ... 5	15
K501	6	24	M510	5 ... 6	17
K502	5	24	M800	4 ... 6	18
K505	8	30			
K510	6.5	45			

Design and Development Process

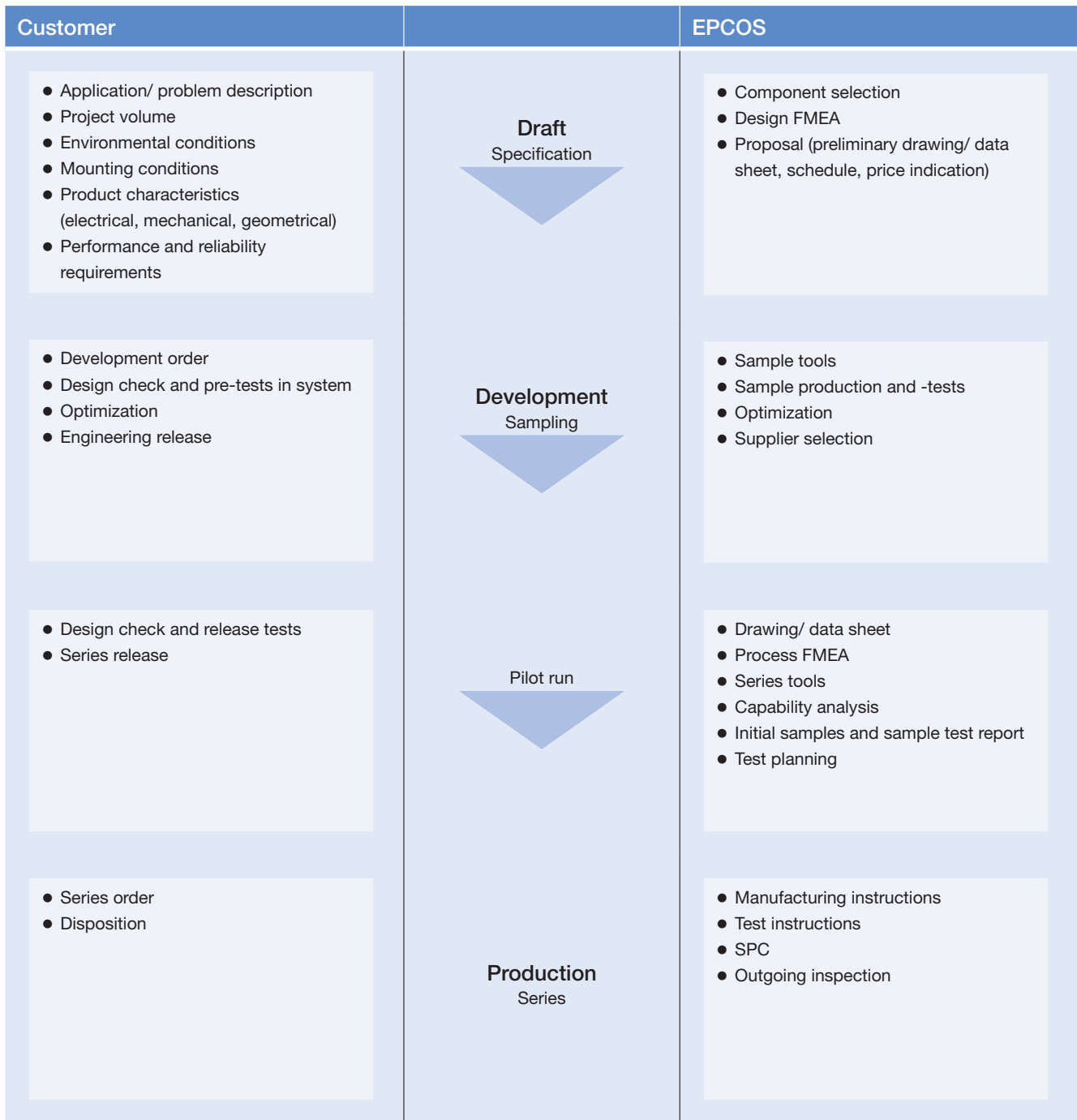

FMEA = Failure Modes and Effects Analysis

SPC = Statistical Process Control

Thermal Response Time Measurement of NTC Sensors

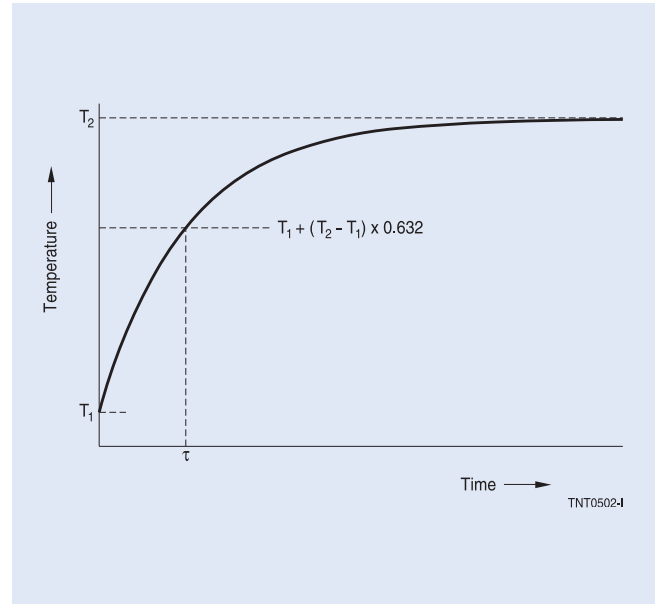
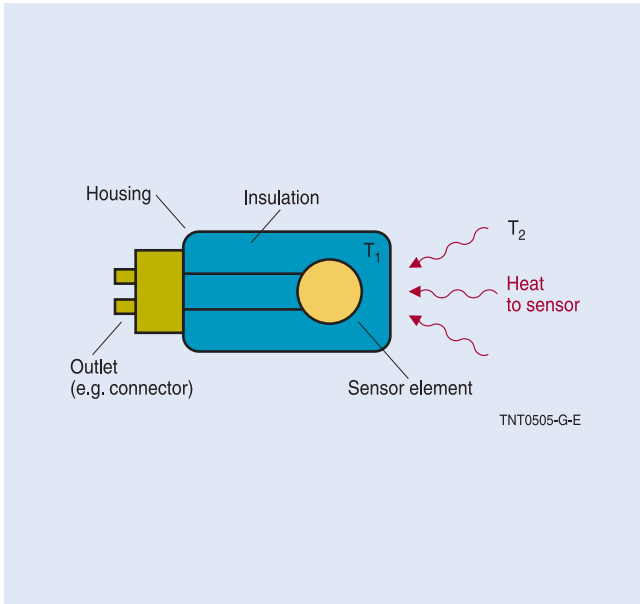

Thermal response time can be a crucial parameter when selecting a temperature sensor to match an application. Receiving raw data in the right time enable engineers to optimize energy efficiency and improve operating safety and convenience in various applications.

The thermal response time of a temperature sensor is mainly influenced by:

- its design (e.g. sensor element, material used to assemble the sensor element in the sensor case, connection technology, housing),
- its mounting configuration (e.g. immersed, surface-mounted),
- the environment it will be exposed to (e.g. air flow, inactive air, fluid).

EPCOS possesses extensive and sophisticated inhouse facilities to test the performance and reliability of temperature sensors. Test stations exist to carry out thermal response time measurement in air/water or air/air. The item is mounted in a defined position and tests are run under reproducible and user-defined conditions. In this way it is possible to compare the test results of different temperature sensors.

Definition of thermal response time

When a temperature sensor with a temperature T_1 is immersed in a medium (air, fluid) with a temperature T_2 , the change in temperature of the sensor as a function of time follows to a first approximation the following equation:

$$T(t) = T_2 + (T_1 - T_2) \cdot e^{-\frac{t}{\tau}}$$

where τ is the thermal response time (thermal time constant). After the time τ (also denoted $t_{0.63}$) the temperature change of the sensor is 63.2% of the temperature difference $T_1 - T_2$, which follows from:

$$T(\tau) = T_1 + (T_2 - T_1) \cdot \left(1 - \frac{1}{e}\right)$$

Thermal Response Time Measurement of NTC Sensors

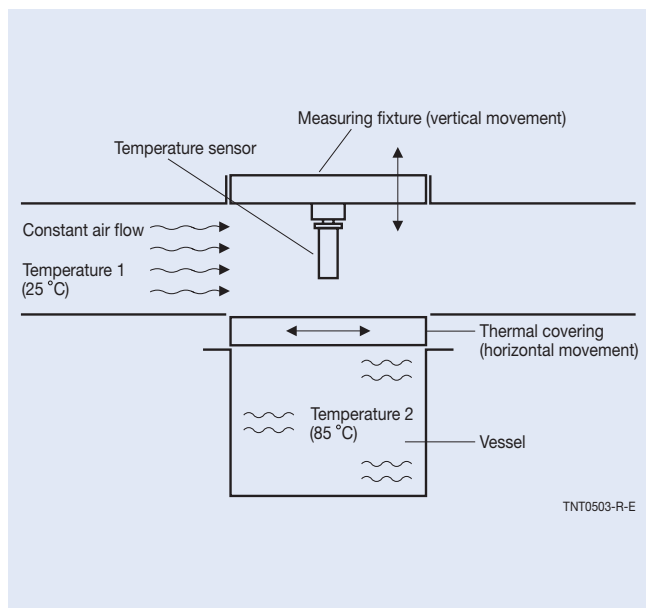

Measurement of thermal response time in water

The thermal response time is determined by a modified two bath method according to EN 60539, outlined in the schematic above. The temperature sensor is held in an air channel having the temperature T_1 . Below the air channel is a vessel filled with water having a temperature T_2 . The thermal covering between air channel and vessel takes the form of a slider that can be moved horizontally.

Before measurement, the zero-power resistance of the NTC thermistor at T_1 , T_2 and a temperature between T_1 and T_2 are determined in a temperature controlled bath. The resistance values and related temperature values are fed into the measurement software. Then the temperature sensor, mounted in a dedicated test fixture, is exposed to an air flow constantly controlled to temperature T_1 until it has reached the surrounding temperature. Afterwards the slider is moved horizontally and simultaneously the fixture is quickly moved vertically to immerse the temperature sensor in the vessel. A digital multimeter records the resistance during the thermal transient of the temperature sensor. The software analyzes the data and calculates the thermal response time $t_{0.63}$.

By default T_1 is set to 25 °C, T_2 is set to 85 °C.

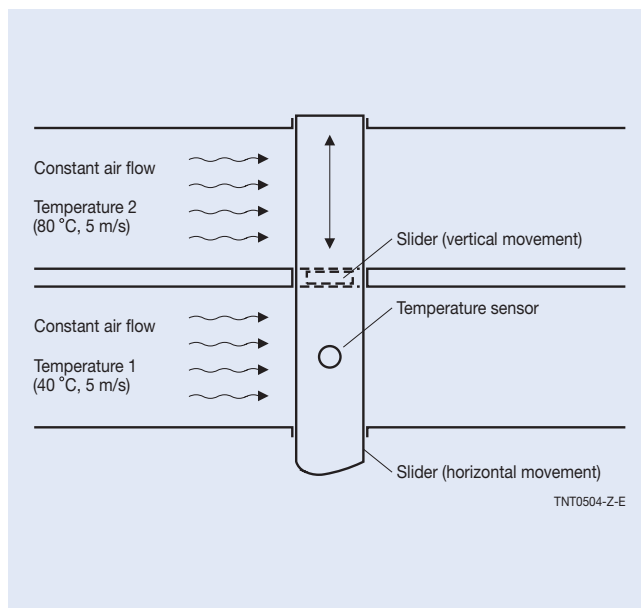

Measurement of thermal response time in air

The thermal response time is determined by a double air channel method whose temperatures can be set separately. Furthermore, the air speed in each channel can be adjusted and measured with a calibrated anemometer.

The schematic above shows the two air channels from the top side. The temperature sensor is mounted on a suitable test fixture and can be moved horizontally from one air channel to the other. A slider between the two air channels can be moved vertically and opens a gap between the two air channels during movement of the sensor.

First the resistance values of the NTC thermistor are determined at three different temperatures in a temperature controlled bath and the temperature and resistance values are fed into the measurement software to set the R/T characteristics of the thermistor. Then the temperature sensor is mounted on the fixture. When the test run starts, the temperature sensor is placed in one air channel with defined air speed and stabilized at temperature T_1 . The sensor is then quickly moved to the other air channel with the same air speed at upper temperature T_2 . During the thermal transient of the temperature sensor a digital multimeter records the resistance and elapsed time. The software calculates the thermal response time $t_{0.63}$.

By default T_1 is set to 40 °C, T_2 is set to 80 °C, and air speed is adjusted to 5 m/s.

Cautions and Warnings

General

See "Important notes" on page 4.

Storage

- Store thermistors in original packaging only. Do not open the package prior to storage.
- Storage conditions in original packaging: storage temperature $-25\text{ °C} \dots +45\text{ °C}$, relative humidity 75% annual mean, maximum 95%, dew precipitation is inadmissible.
- Do not store thermistors where they are exposed to heat or direct sunlight. Otherwise, the packing material may be deformed or components may stick together, causing problems during mounting.
- Avoid contamination of thermistor surface during storage, handling and processing.
- Avoid storage of thermistors in harmful environments like corrosive gases (SO_x , Cl etc.)
- Use the components as soon as possible after opening the factory seals, i.e. the polyvinyl-sealed packages.
- Solder thermistors within the time specified after shipment from EPCOS.

Handling

- NTC thermistors must not be dropped. Chip-offs or any other damage must not be caused during handling of NTCs.
- Do not touch components with bare hands. Gloves are recommended.
- Avoid contamination of thermistor surface during handling.

Soldering

- Use resin-type flux or non-activated flux.
- Insufficient preheating may cause ceramic cracks.
- Rapid cooling by dipping in solvent is not recommended.
- Complete removal of flux is recommended.

Mounting

- Any thermo-mechanical stress to the NTC thermistors should be avoided. This applies, for example, to sealing, potting or overmolding during production processes as well as to the subsequent operation of the thermistors. The specified maximum temperature of the thermistor must not be exceeded. Ensure that the materials used (sealing/ potting compounds and plastic materials) are chemically neutral.

- Electrodes/ contacts must not be scratched or damaged before/ during/ after the mounting process.
- Contacts and housing used for assembly with the thermistor must be clean before mounting.
- Ensure that adjacent materials are designed for operation at temperatures comparable to the surface temperature of the thermistor. Be sure that surrounding parts and materials can withstand the temperature.
- Avoid contamination of the thermistor surface during processing.
- The connections of sensors (e.g. cable end, wire end, plug terminal) may only be exposed to an environment with normal atmospheric conditions.
- Tensile forces on cables or leads must be avoided during mounting and operation.
- Bending or twisting of cables or leads directly on the thermistor body is not permissible.
- Avoid using chemical substances as mounting aids. It must be ensured that no water or other liquids enter the NTC thermistors (e.g. through plug terminals). In particular, water based substances (e.g. soap suds) must not be used as mounting aids for sensors.

Operation

- Use thermistors only within the specified operating temperature range.
- Use thermistors only within the specified power range.
- Environmental conditions must not harm the thermistors. Only use the thermistors under normal atmospheric conditions or within the specified conditions.
- Contact of NTC thermistors with any liquids and solvents should be prevented. It must be ensured that no water enters the NTC thermistors (e.g. through plug terminals). For measurement purposes (checking the specified resistance vs. temperature), the component must not be immersed in water but in suitable liquids (e.g. Galden).
- Avoid dewing and condensation unless thermistor is specified for these conditions.
- Bending or twisting of cables and/ or wires is not permissible during operation of the sensor in the application.
- Be sure to provide an appropriate fail-safe function to prevent secondary product damage caused by malfunction.

Symbols and Terms

Symbol	Term
AWG	American Wire Gauge
Δ	Tolerance
ECU	Electronic Control Unit
HVAC	Heating, ventilation, air-conditioning
L0, L1, L2, L3	Customer-specific lengths
NTC thermistor	Thermally sensitive resistor with a negative temperature coefficient, i.e. it shows a decrease in resistance as temperature increases.
PTFE	Poly tetra fluor ethylene (also known as Teflon)
R_{25}	Rated resistance ($T = 25\text{ }^{\circ}\text{C}$)
RAST	RAST standards, plug connector system RAST 2.5 refers to multiple-wire connectors with a 2.5 mm pitch or spacing. RAST 5 defines the parameters for connectors with a 5 mm pitch.
R/T characteristics	Resistance/ Temperature characteristics
T_R	Rated temperature
τ_a	The thermal time constant is the time required for an unloaded NTC thermistor to change its body temperature by 63.2% of the temperature difference when it is transferred between two media.
$\tau_{a,\text{air}}$	Thermal response time, measured in air
$\tau_{a,\text{water}}$	Thermal response time, measured in water
$V_{\text{ins}} @ 1\text{ s}$	Insulation voltage, measured for 1 second

Get in Contact

Europe

Austria, Bulgaria, Greece, Macedonia
EPCOS OHG
Vienna/Austria
T +43 51 70 72 56 37
F +43 51 70 75 56 45
sales.csee@epcos.com

Czech Republic
EPCOS s.r.o.
Prague
T +420 2 33 03 22 81
F +420 2 33 03 22 89
sales.czech@epcos.com

Finland, Estonia
EPCOS Nordic OY
Espoo
T +358 9 54 80 70 00
F +358 9 54 80 70 01
sales.nordic@epcos.com

France, Belgium, Luxembourg, Malta
EPCOS SAS
Pantin/France
T +33 1 49 46 67 89
F +33 1 49 46 67 67
sales.france@epcos.com

Germany, Liechtenstein, Netherlands, Switzerland
EPCOS AG
Customer Service
Munich/Germany
T (D) 0180 500 33 48
(0.14 Euro/min.)
(NL) +31 70 33 10 611
(CH) +49 89 63 62 55 40
F +49 89 63 62 80 10
sales.germany@epcos.com

Hungary
EPCOS Elektronikai
Alkatrész Kft.
Budapest
T +36 1 436 07 20
F +36 1 436 07 21
sales.hungary@epcos.com

Italy
TDK-EPC Italy S.r.l.
Milan
T +39 02 50 99 54 25
F +39 02 50 99 54 55
sales.italy@epcos.com

Poland, Latvia, Lithuania
EPCOS Polska Sp. z o.o.
Warsaw/Poland
T +48 22 24 60 409
F +48 22 24 60 400
sales.poland@epcos.com

Portugal
EPCOS 2 Portugal LDA
Évora
T +351 91 75 67 927
F +351 21 49 33 476
sales.portugal@epcos.com

Romania
EPCOS Sales Representative
Timisoara
T +40 72 31 14 111
sales.romania@epcos.com

Russia, Belarus, Kazakhstan, Moldavia, Ukraine
EPCOS LLC
Moscow/Russia
T +7 495 663 21 00 / 22
sales.cis@epcos.com

Slovakia
EPCOS Sales Representative
Dolný Kubín
T +42 1 43 5 82 36 73
F +42 1 43 5 82 37 33
sales.slovakia@epcos.com

Slovenia, Serbia, Croatia, Bosnia & Herzegovina, Montenegro
EPCOS Sales Representative
Škofljica/Slovenia
T +386 599 56 35 3
F +386 599 56 35 4
sales.slovenia@epcos.com

Spain
EPCOS Electronic Components S.A.
Getafe
T +34 91 514 71 61
F +34 91 514 70 14
sales.iberia@epcos.com

Sweden, Iceland, Denmark, Norway
EPCOS Nordic AB
Kista/Sweden
T +46 8 4 77 27 00
F +46 8 4 77 27 01
sales.nordic@epcos.com

Turkey
EPCOS AG
Liaison Office
Istanbul
T +90 216 5 69 81 01
F +90 216 4 64 07 56
sales.turkey@epcos.com

United Kingdom, Ireland
EPCOS UK Ltd.
Bracknell/UK
T +44 13 44 38 15 10
F +44 13 44 38 15 12
sales.uk@epcos.com

Asia

Afghanistan, Iran, Iraq, Jordan, Lebanon, Pakistan, Syria
EPCOS AG
Liaison Office
Istanbul/Turkey
T +90 216 5 69 81 01
F +90 216 4 64 07 56
sales.turkey@epcos.com

China
EPCOS (China) Investment Ltd.
EPCOS (Shanghai) Ltd.
Shanghai
T +86 21 22 19 15 00
F +86 21 22 19 15 99
sales.cn@epcos.com

Hong Kong
EPCOS Limited
Hong Kong
T +852 36 69 82 00
F +852 36 69 82 56
sales.cn@epcos.com

India, Bahrain, Bangladesh, Kuwait, Nepal, Oman, Qatar, Saudi Arabia, Sri Lanka, United Arab Emirates
EPCOS India Private Ltd.
Bangalore/India
T +91 80 40 39 06 15
F +91 80 40 39 06 03
sales.in@epcos.com

Israel
Nisko Projects Electronics & Communications (1999) Ltd.
Tel Aviv
T +972 37 65 73 00
F +972 37 65 73 33
sales.israel@epcos.com

Japan
TDK-EPC Corporation
Tokyo
T +81 3 52 01 72 41
F +81 3 52 01 72 62
inquiry@jp.tdk.com

Korea
TDK-EPC Korea Co. Ltd.
Seoul
T +82 2 21 56 68 18
F +82 2 21 56 68 98
sales.kr@epcos.com

Malaysia
EPCOS RDC SDN BHD
Nilai
T +60 6 79 98 168
F +60 6 79 98 162
sales.asean@epcos.com

Philippines
c/o TDK Electronics Philippines Corporation
Biñan
T +63 49 541 31 41 66 30 / 31
F +63 49 541 31 40
sales.asean@epcos.com

Singapore, Indonesia, Thailand, Vietnam
EPCOS PTE LTD
Singapore
T +65 68 41 20 11
F +65 67 44 69 92
sales.asean@epcos.com

Taiwan
EPCOS Taiwan Co. Ltd.
Taipei
T +886 2 26 55 76 76
F +886 2 27 82 03 89
sales.tw@epcos.com

Americas

USA, Canada, Mexico
EPCOS, Inc.
Iselin, NJ/USA
T +1 732 9 06 43 00
F +1 732 9 06 43 95
sales.usa@epcos.com

South America
EPCOS do Brasil Ltda.
São Paulo/Brazil
T +55 11 36 12 51 87
F +55 11 36 12 51 65
sales.br@epcos.com

Australia

Australia, New Zealand
Electronic Component Solutions Pty Ltd
Melbourne/Australia
T +61 3 85 61 19 99
F +61 3 95 74 70 55
sales.au@epcos.com

Africa

Egypt
EPCOS AG
Liaison Office
Istanbul/Turkey
T +90 216 5 69 81 01
F +90 216 4 64 07 56
sales.turkey@epcos.com

Morocco, Tunisia
EPCOS SAS
Pantin/France
T +33 1 49 46 67 89
F +33 1 49 46 67 67
sales.france@epcos.com

South Africa
Electrocomp (PTY) Ltd.
Sandton
T +27 11 458 90 00 32
F +27 11 458 90 34
sales.southernafrica@epcos.com

The addresses of our worldwide distributors and regional sales offices are available at www.epcos.com/sales

